

# MASTER-TOUCH PREMIUM

ASSEMBLY GUIDE  
ENSEMBLE GUIDE  
MONTAGEANLEITUNG

E-5770  
SE E-5775



57cm



Read the owner's guide before using the barbecue.

Lisez le guide d'utilisation avant d'utiliser le barbecue.

Bitte lesen Sie das Benutzerhandbuch, bevor Sie den Grill verwenden.



**54806**

100118

enGB / da / de / es / fi / fr / it / nl / no / pl / pt / ru / sv

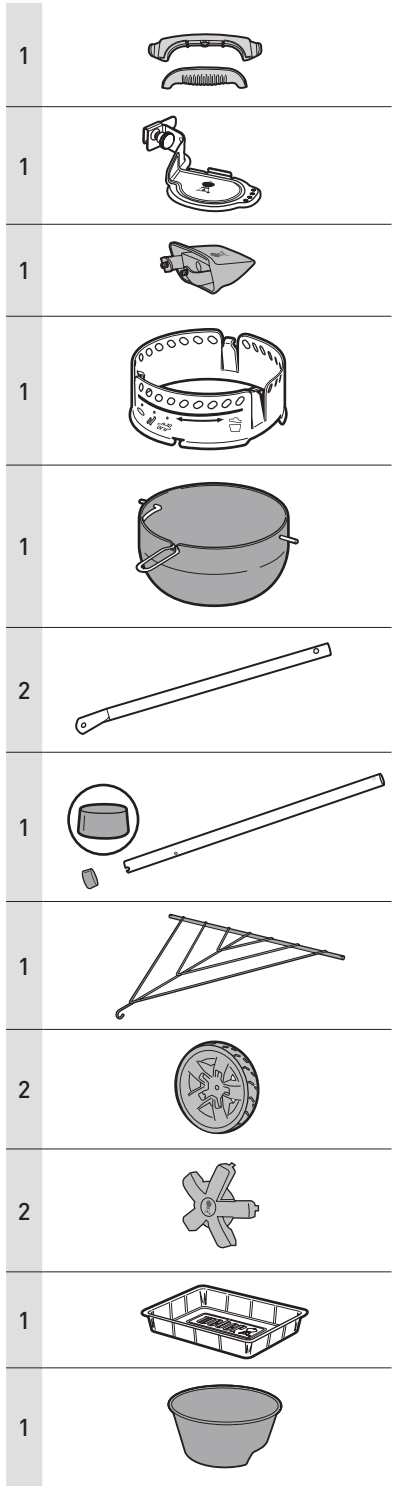
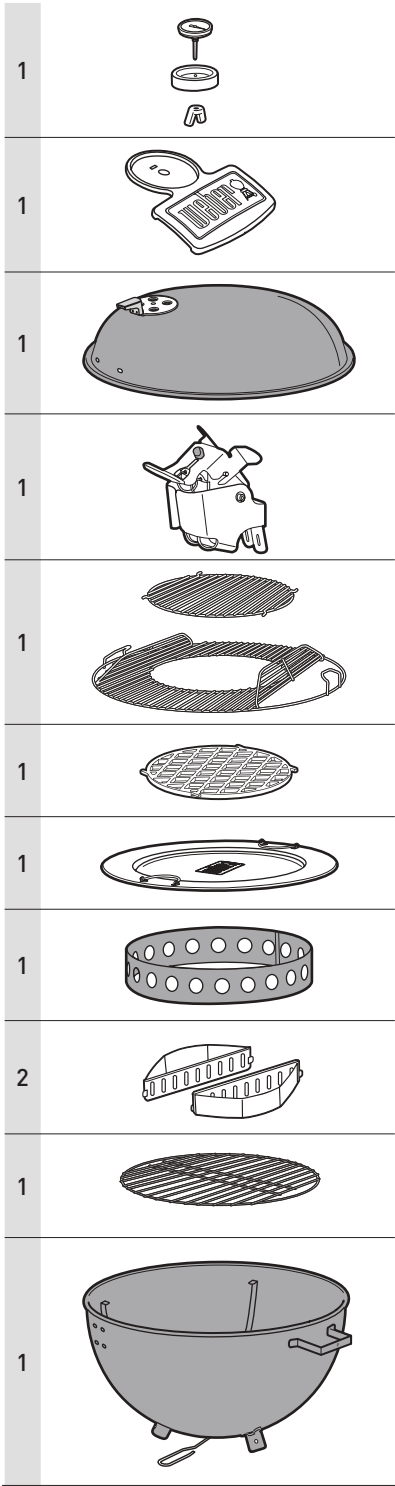

EN TOOLS INCLUDED:

DA MEDFØLGENDE VÆRKTØJER:

DE ENTHALTENE WERKZEUGE:

ES HERRAMIENTAS INCLUIDAS:

FI SISÄLTÄVÄT TYÖKALUT:

FR OUTILS INCLUS :

IT ATTREZZI INCLUSI:

NL INBEGREPEN

GEREEDSCHAPPEN:

NO VERKTØY INKLUDERT:

PL DOŁĄCZONE NARZĘDZIA:

PT FERRAMENTAS INCLUIDAS:

RU ИНСТРУМЕНТЫ ВКЛЮЧЕНЫ:

SV VERKTYG SOM MEDFÖLJER:

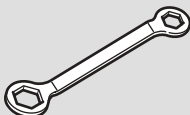

EN TOOLS REQUIRED:

DA VÆRKTØJ PÅKRÆVET:

DE ERFORDERLICHES WERKZEUG:

ES HERRAMIENTAS NECESARIAS:

FI TARVITTAVAT TYÖKALUT:

FR OUTILS NÉCESSAIRES:

IT ATTREZZI NECESSARI:

NL BENODIGD GEREEDSCHAP:

NO NØDVENDIG VERKTØY:

PL WYMAGANE NARZĘDZIA:

PT FERRAMENTAS NECESSÁRIAS:

RU НЕОБХОДИМЫЕ  
ИНСТРУМЕНТЫ:

SV NÖDVÄNDIGA VERKTYG:

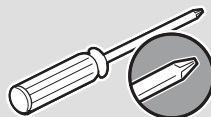

2



6

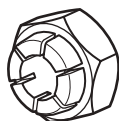

3

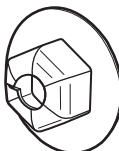

3

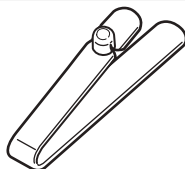

1



1

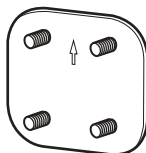

1

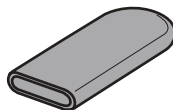

2

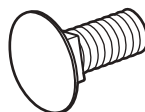

EN Download the free BILT app for 3D step-by-step instructions.

DA Download den gratis BILT-app med trin-for-trin-vejledning i 3D.

DE Lade die kostenlose BILT-App herunter, um dir eine Schritt-für-Schritt-Anleitung in 3D anzeigen zu lassen.

ES Descargue gratis la app BILT para recibir instrucciones paso a paso en 3D.

FI Lataa 3D-ohjeet sisälltävä ilmainen BILT-sovellus.

FR Téléchargez l'appli gratuite BILT qui vous expliquera le montage étape par étape en 3D.

IT Per istruzioni 3D dettagliate, scaricare l'app gratuita BILT.

NL Download de gratis BILT-app voor stapsgewijze 3D-instructies.

NO Last ned BILT-appen gratis for trinvisse veiledninger i 3D.

PL Pobierz bezpłatną aplikację BILT z instrukcjami 3D krok po kroku.

PT Faça o download da aplicação BILT gratuita para obter instruções 3D passo a passo.

RU Загрузите бесплатное приложение BILT для получения пошаговой 3D-инструкции.

SV Ladda ned den kostnadsfria BILT-appen för steg-för-steg-instruktioner i 3D.

2

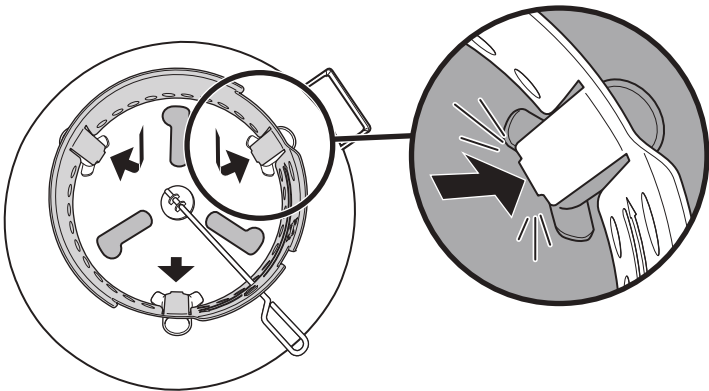
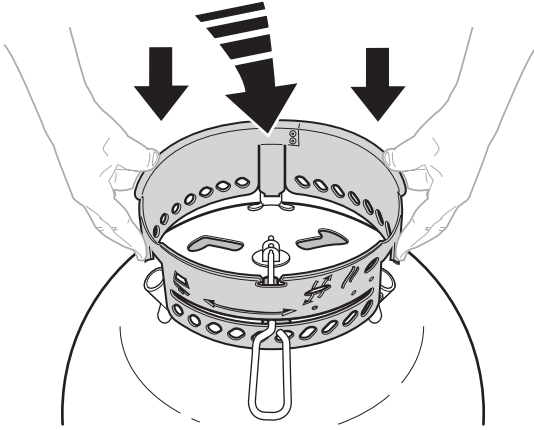
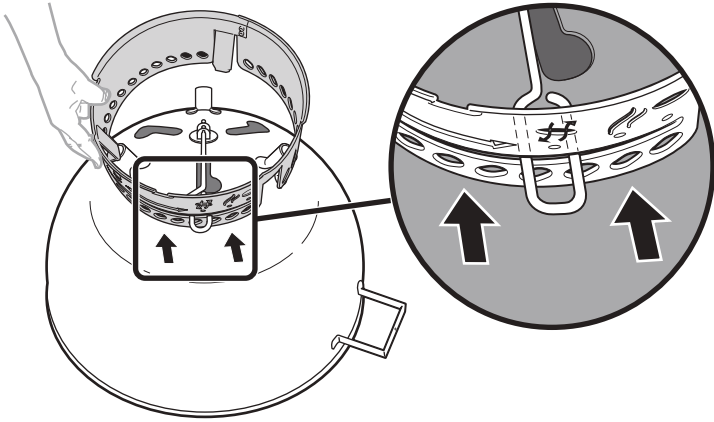

3

1-

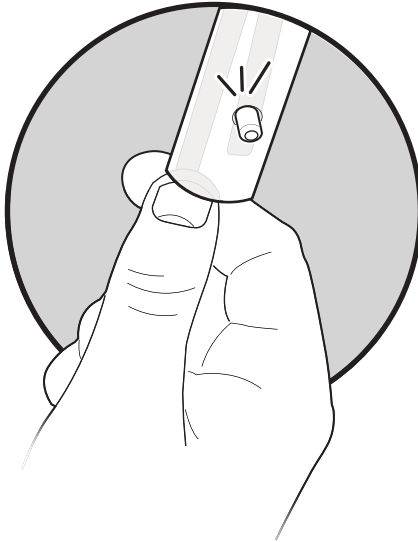
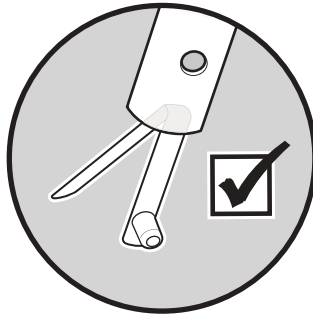
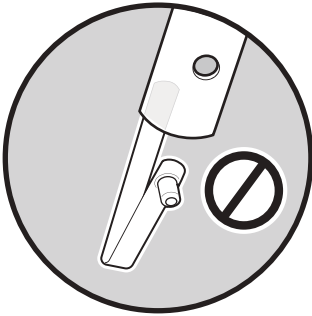
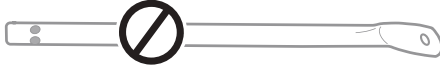
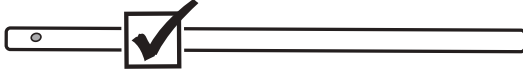
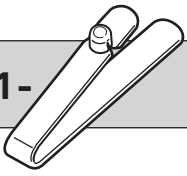

4

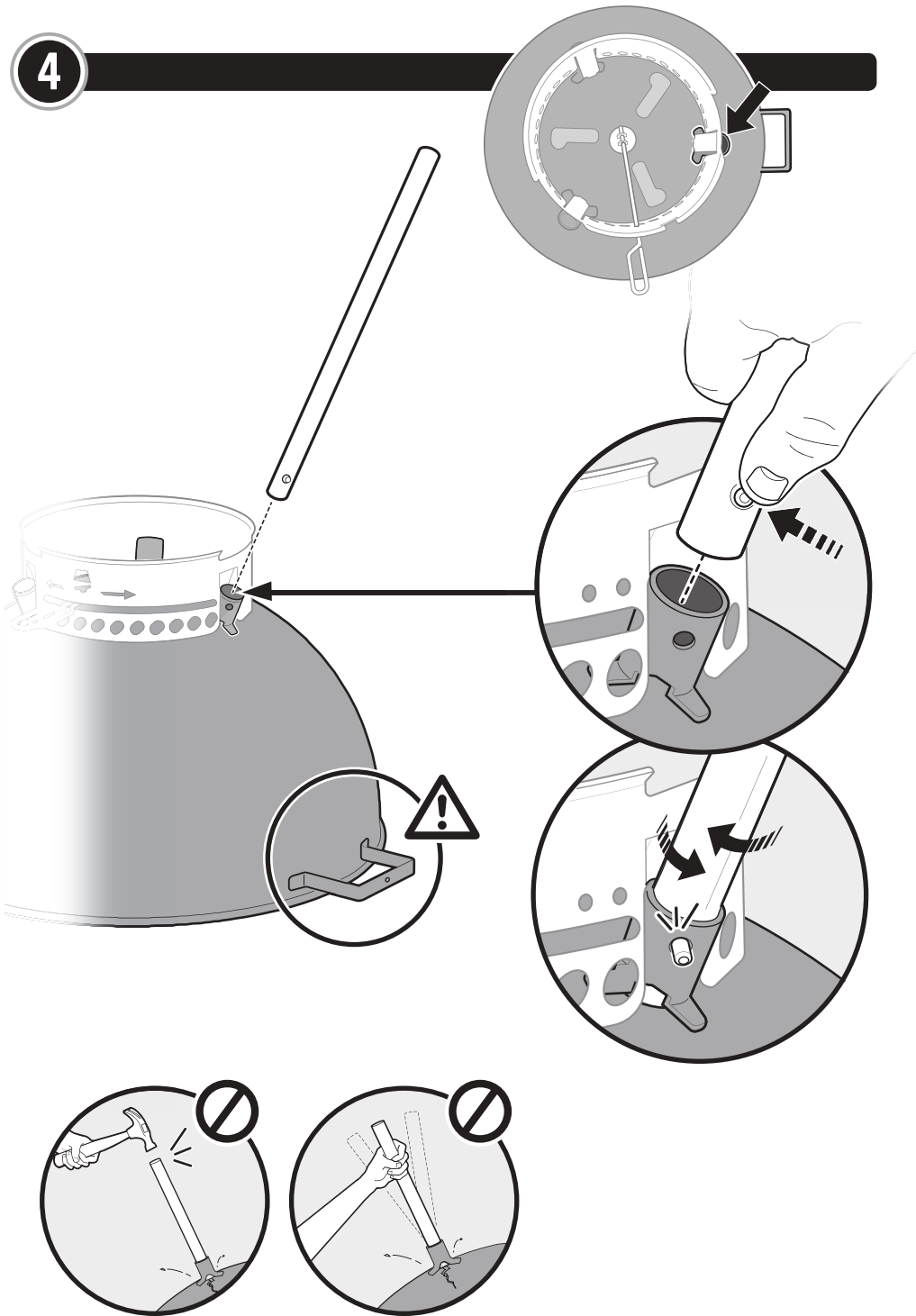

5

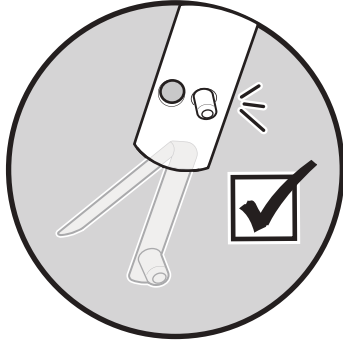
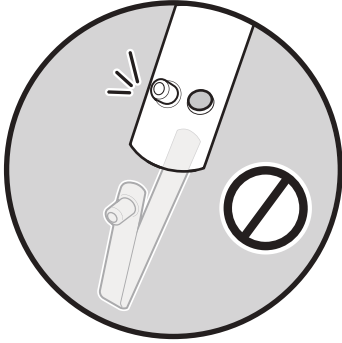
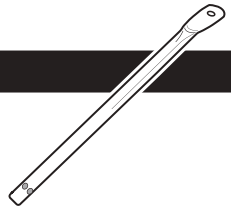
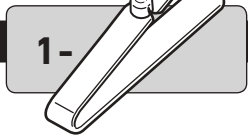

6

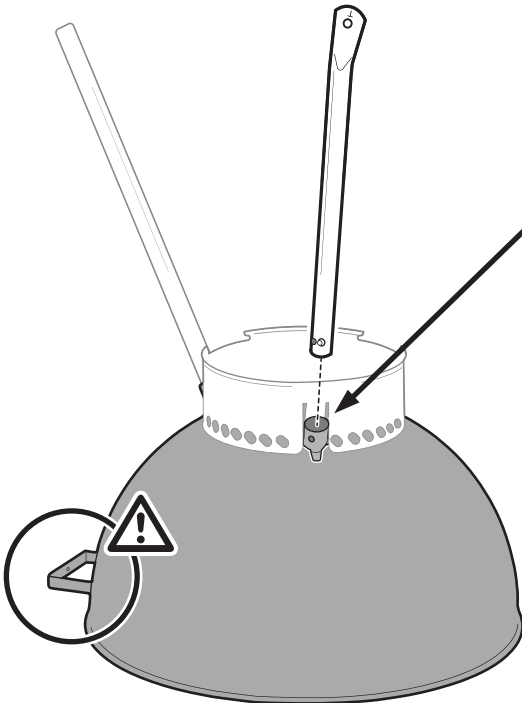

7

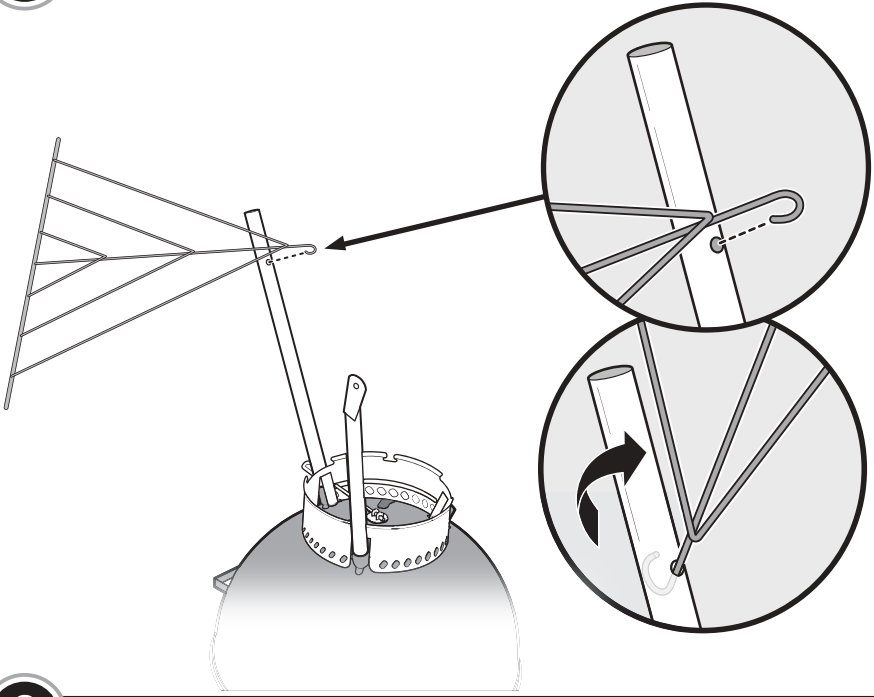

8

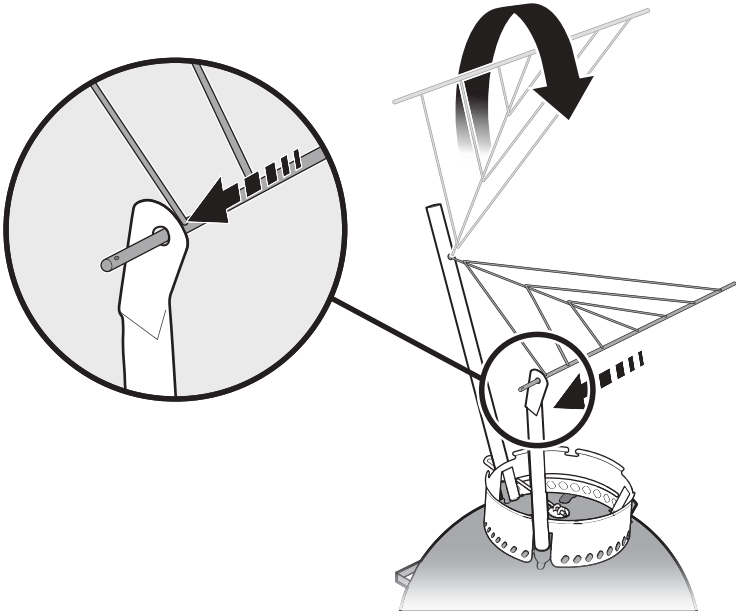



9

1-

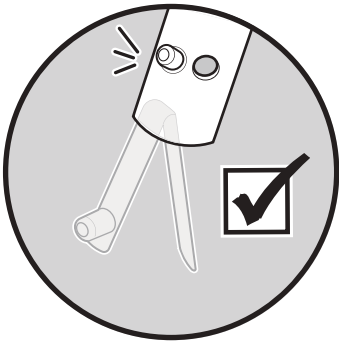
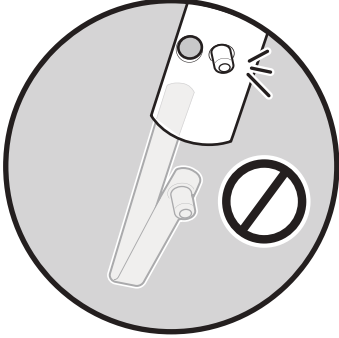
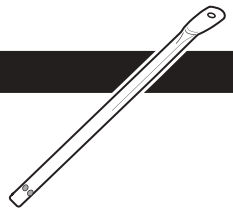
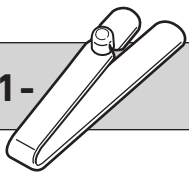

10

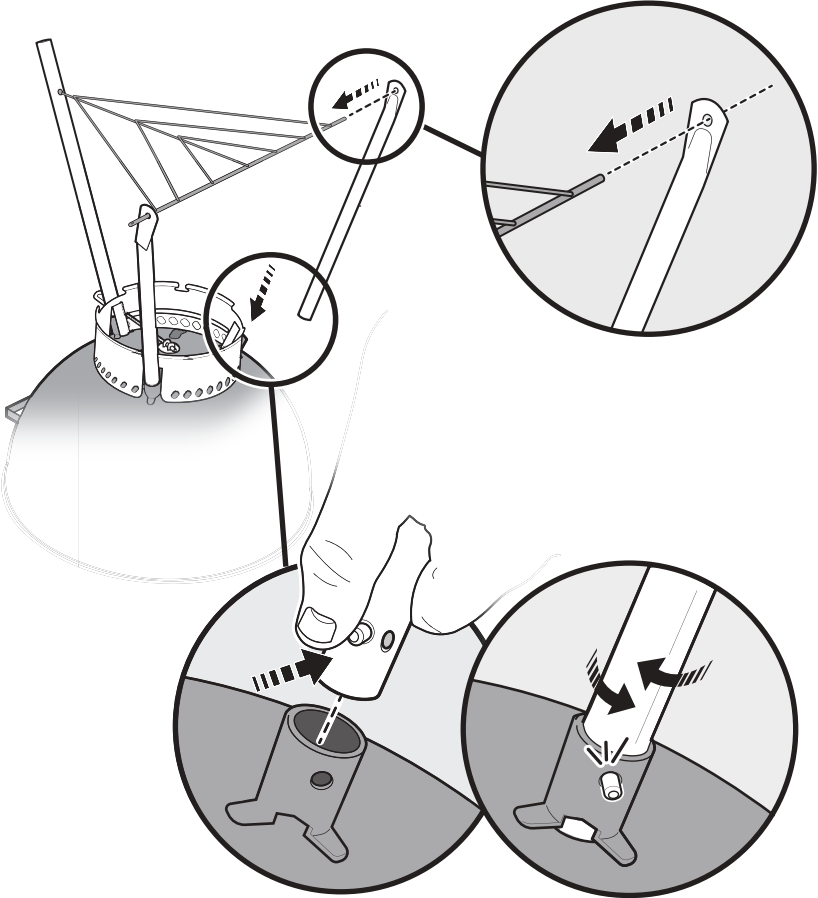

11

2-  2- 

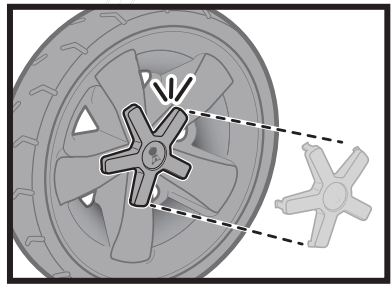
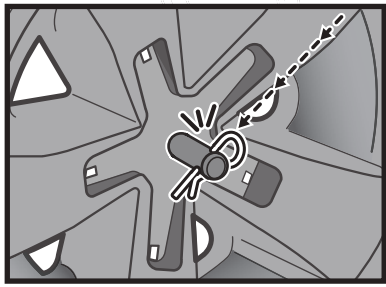
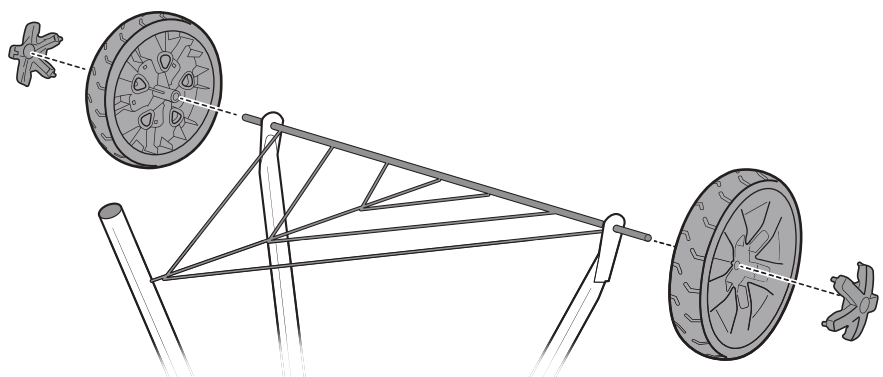

12

1- 

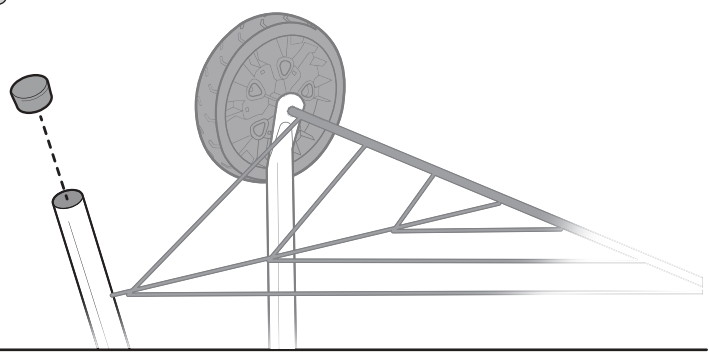

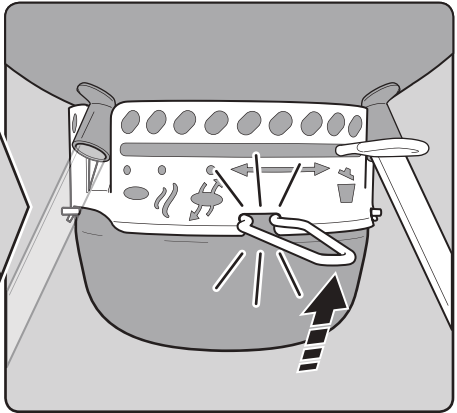
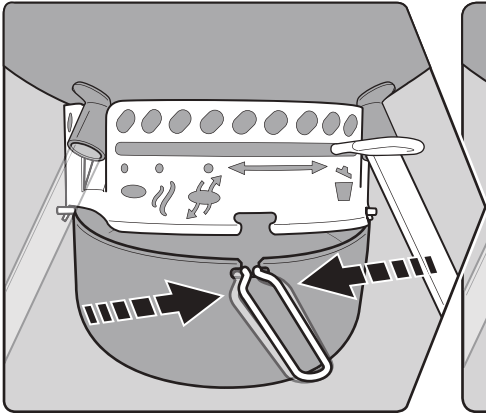
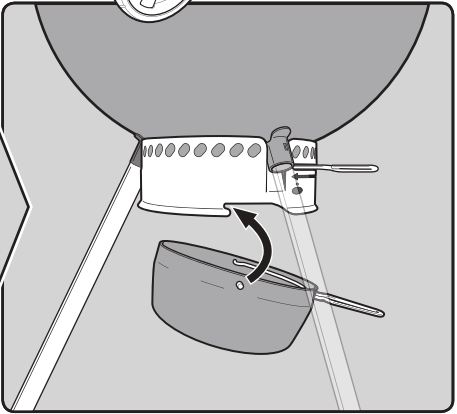
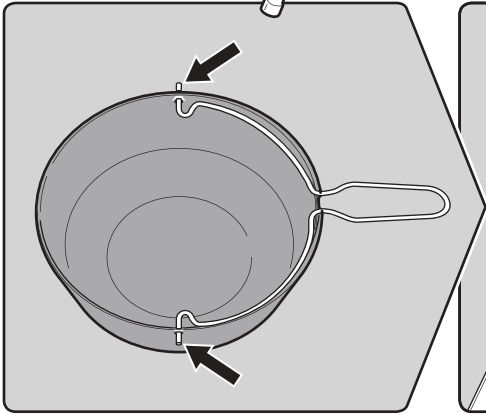
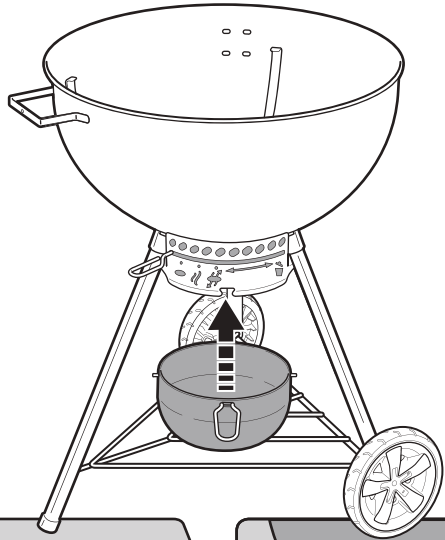

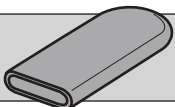

14

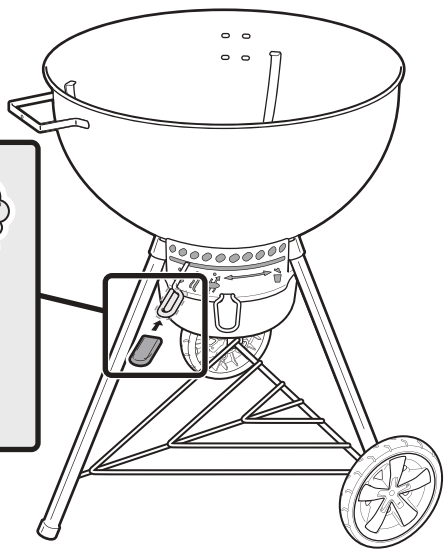
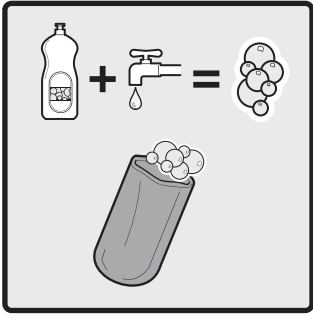
1- 



15

  1- 

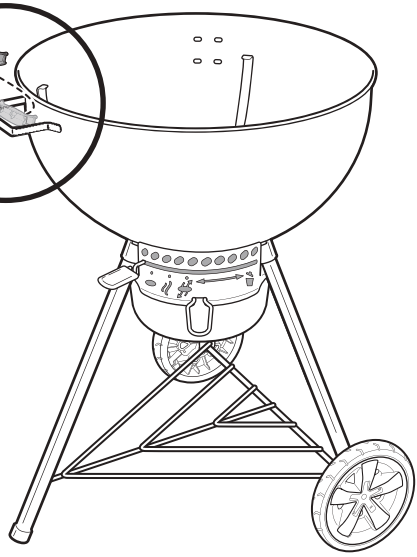
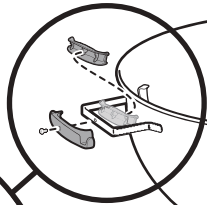
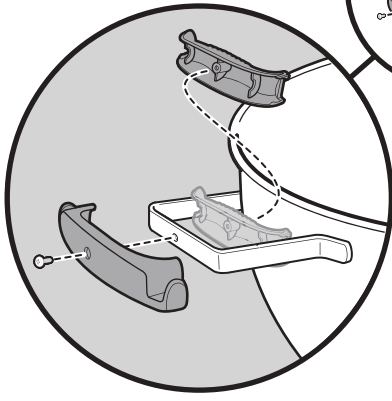

16

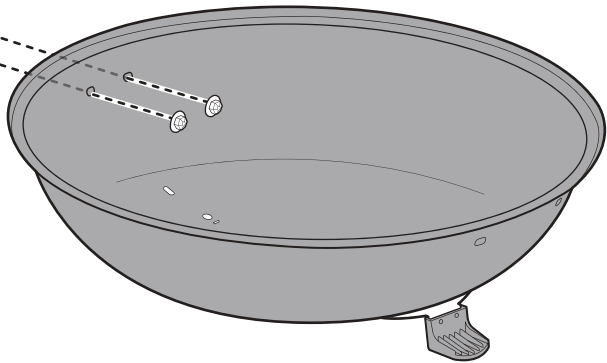
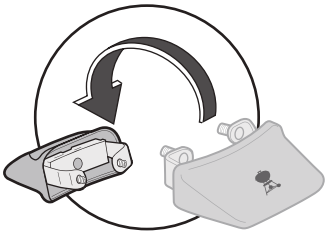

17

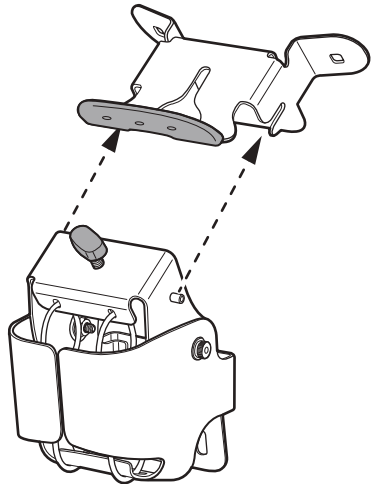
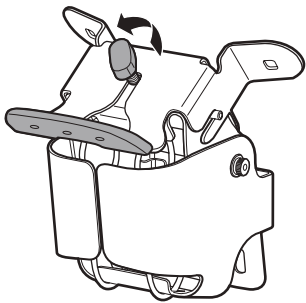

18

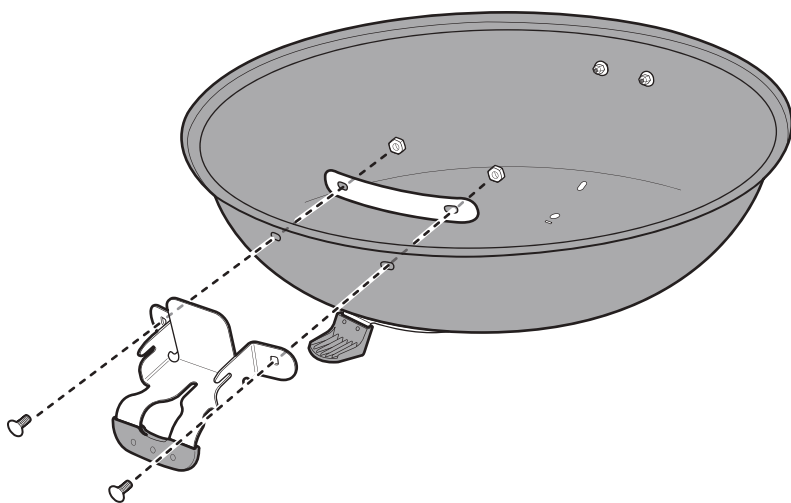
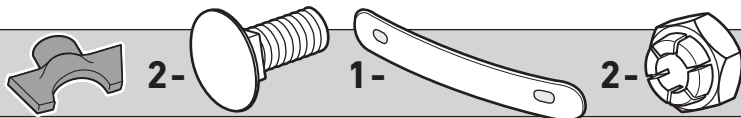

19

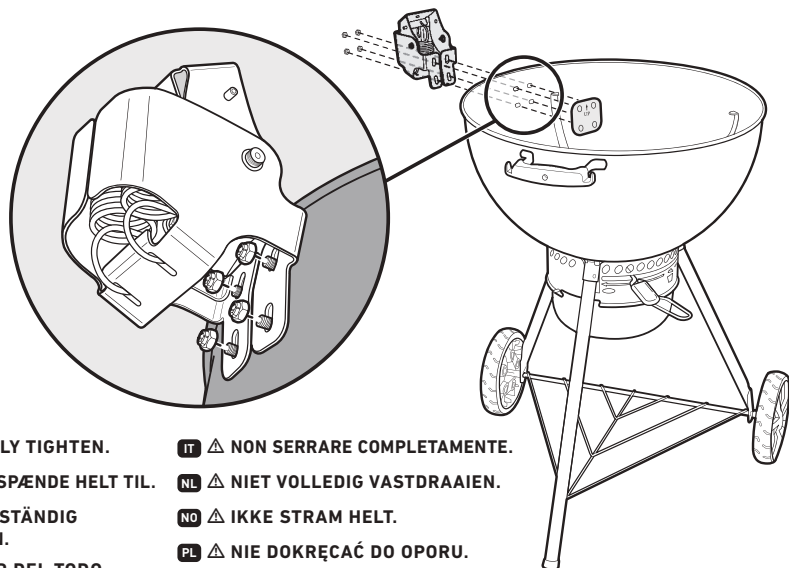
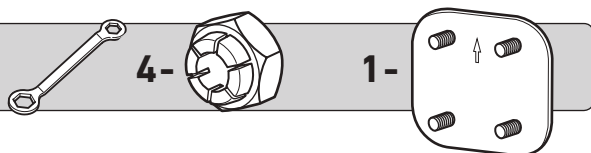

**EN** ⚠ DO NOT FULLY TIGHTEN.

**DA** ⚠ UNDLAD AT SPÆNDE HELT TIL.

**DE** ⚠ NICHT VOLLSTÄNDIG FESTZIEHEN.

**ES** ⚠ NO APRETAR DEL TODO.

**FI** ⚠ ÄLÄ KIRISTÄ KOKONAAN.

**FR** ⚠ NE PAS SERRER TROP FORTEMENT.

**IT** ⚠ NON SERRARE COMPLETAMENTE.

**NL** ⚠ NIET VOLLEDIG VASTDRAAIEN.

**NO** ⚠ IKKE STRAM HELT.

**PL** ⚠ NIE DOKRĘCAĆ DO OPORU.

**PT** ⚠ NÃO APERTAR NA TOTALIDADE.

**RU** ⚠ НЕ ЗАТЯГИВАЙТЕ ПОЛНОСТЬЮ.

**SV** ⚠ DRA INTE ÄT MUTTRARNA HELT.

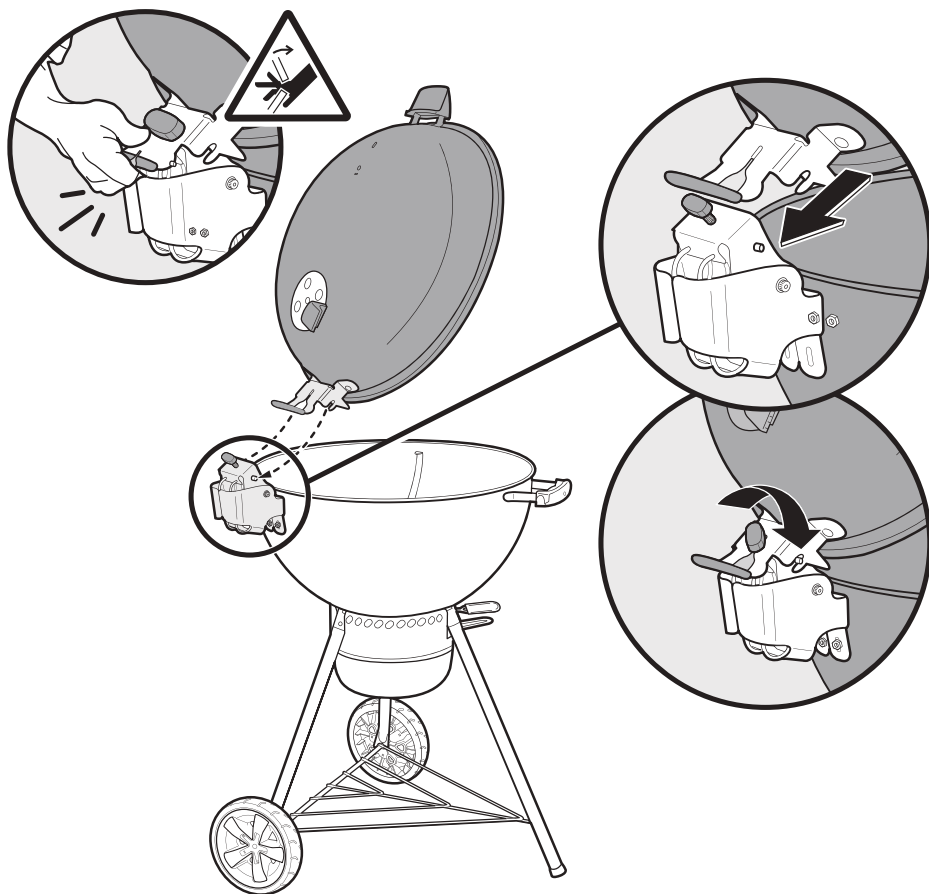

- EN** ▲ FULLY TIGHTEN THE KNOB.
- DA** ▲ SPÆND SKRUEN HELT TIL.
- DE** ▲ FEST ANZIEHEN.
- ES** ▲ APRETAR DEL TODO.
- FI** ▲ KIRISTÄ NUPPI KOKONAAN.
- FR** ▲ SERRAGE COMPLET DU BOUTON.
- IT** ▲ SERRARE COMPLETAMENTE LA MANOPOLA.
- NL** ▲ KNOP VOLLEDIG VASTDRAAIEN.
- NO** ▲ STRAM KNOTTEN HELT.
- PL** ▲ DOKRĘCIĆ POKRĘTŁO DO OPORU.
- PT** ▲ APERTAR O BOTÃO NA TOTALIDADE.
- RU** ▲ ЗАТЯНИТЕ ПОЛНОСТЬЮ РУЧКУ.
- SV** ▲ DRA ÅT VREDET HELT.

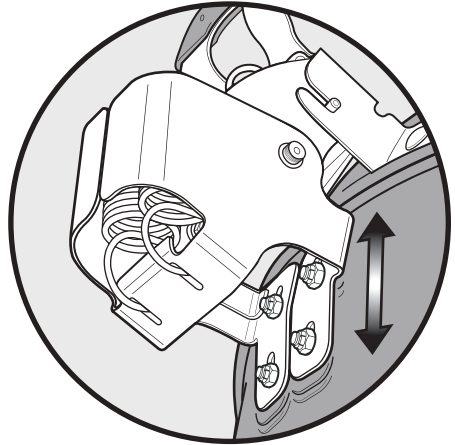
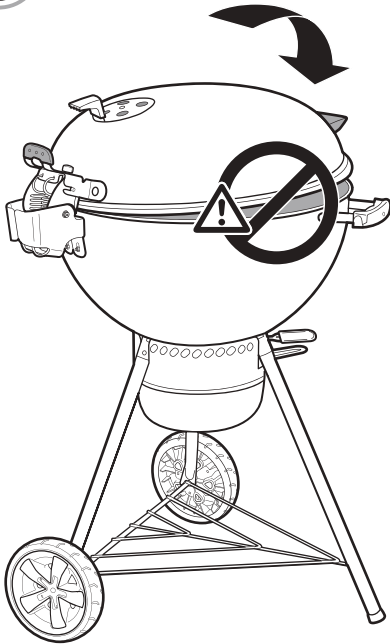

**EN** ⚠ BE SURE THAT THE LID IS FLAT ON THE BOWL. KEEP LID CLOSED AND ADJUST LOWER HINGE IF NECESSARY BEFORE TIGHTENING HARDWARE.

**DA** ⚠ KONRTROLLÉR, AT LÅGET LIGGER FLADT MOD BUNDEN. HOLD LÅGET LUKKET, OG JUSTER OM NØDVENDIGT DET NEDERSTE HÆNGSEL, INDEN DU FORETAGER DE NØDVENDIGE TILSPÆNDINGER.

**DE** ⚠ DER DECKEL MUSS FLACH AUF DEM KESSEL AUFLIEGEN. FALLS ERFORDERLICH, KANNST DU DAS UNTERE SCHARNIER BEI GESCHLOSSENEM DECKEL JUSTIEREN, BEVOR DU DIE TEILE FESTZIEHST.

**ES** ⚠ COMPRUEBE QUE LA TAPA ESTÉ COMPLETAMENTE APOYADA EN LA CUBA. SI ES NECESARIO, MANTENGA LA TAPA CERRADA Y AJUSTE LA BISAGRA INFERIOR ANTES DE APRETAR LOS HERRAJES.

**FI** ⚠ VARMISTA, ETTÄ KANSI ON TASASEISTI POHJASTIAN PÄÄLLÄ. PIDÄ KANSI SULJETTUNA JA SÄÄDÄ TARVITTAESSA ALASARANAA ENNEN KIINNIKKEIDEN KIRISTÄMISTÄ.

**FR** ⚠ ASSUREZ-VOUS QUE LE COUVERCLE FERME CORRECTEMENT. FERMEZ LE COUVERCLE ET RÉGLEZ LA CHARNIÈRE INFÉRIEURE SI BESOIN AVANT DE SERRER LES VIS.

**IT** ⚠ ASSICURARSI CHE IL COPERCHIO SIA IN POSIZIONE ORIZZONTALE SUL BRACIERE. TENERE IL COPERCHIO CHIUSO E REGOLARE LA CERNIERA INFERIORE, SE NECESSARIO, PRIMA DI SERRARE LA MINUTERIA.

**NL** ⚠ ZORG DAT HET DEKSEL PLAT OP DE KETEL LIGT. DEKSEL GESLOTEN HOUDEN EN ZO NODIG LAGERE SCHARNIER VERSTELLEN VOOR HET BEVESTIGEN VAN DE HARDWARE.

**NO** ⚠ SJEKK AT LOKKET LIGGER FLATT PÅ BOLLEN. LA LOKKET VÆRE IGJEN, OG JUSTER DET NEDRE HENGSELET HVIS NØDVENDIG FØR DU STRAMMER UTSTYRET.

**PL** ⚠ UPEWNIJ SIĘ, ŻE POKRYWA JEST ZAMKNIĘTA. PRZED DOKRĘCENIEM ŚRUB ZAMKNAĆ POKRYWĘ I W RAZIE POTRZEBY WYREGULOWAĆ DOLNY ZAWIAS.

**PT** ⚠ CERTIFICAR-SE DE QUE A TAMPA ESTÁ BEM ASSENTE NA CUBA. MANTENHA A TAMPA FECHADA E, SE NECESSÁRIO, AJUSTE A DOBRADIÇA INFERIOR ANTES DE APERTAR AS FERRAGENS.

**RU** ⚠ УБЕДИТЕСЬ, ЧТО КРЫШКА РАСПОЛОЖЕНА НА ЧАШЕ РОВНО. ПРИ НЕОБХОДИМОСТИ, ОТРЕГУЛИРУЙТЕ НИЖНИЮ ПЕТЛЮ ПЕРЕД ЗАТЯЖКОЙ КРЕПЛЕНИЯ.

**SV** ⚠ SE TILL ATT LOCKET LIGGER PLANT MOT BALJAN. HÅLL LOCKET STÅNGT OCH JUSTERA VID BEHOV DET NEDRE GÅNGJÄRNET INNAN DU DRAR ÅT MUTTRARNA.



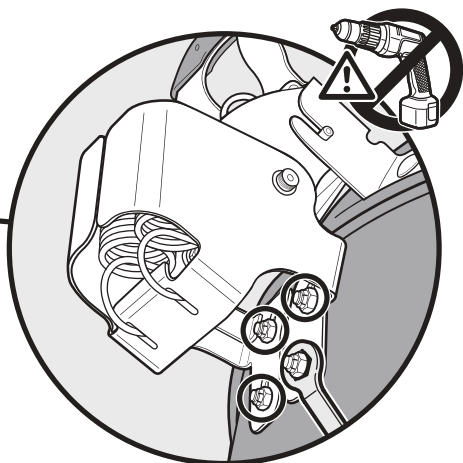
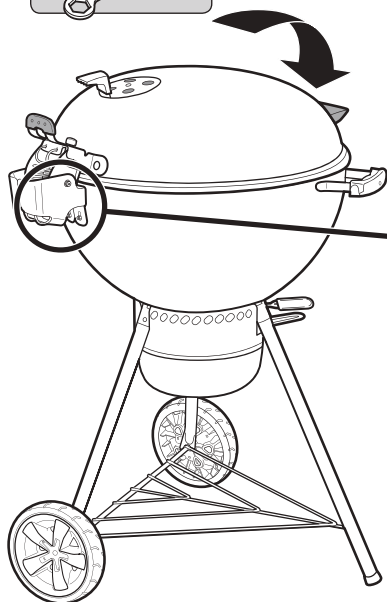
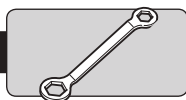

**EN** Tighten hardware until it is secure.

**⚠ DO NOT OVERTIGHTEN HARDWARE.**

For videos and guidance with assembly of the hinge, check our FAQs on [weber.com](http://weber.com).

**DA** Spænd godt til.

**⚠ UNDLAD AT SPÆNDE FOR HÅRDT.** Du kan finde videoer og vejledning i, hvordan du samler hængslet, under Ofte stillede spørgsmål (FAQ) på [weber.com](http://weber.com).

**DE** Befestigungsteile sicher festziehen.

**⚠ BEFESTIGUNGSTEILE NICHT ZU FEST ANZIEHEN.** Videos und Anleitungen zur Montage des Scharniers findest du in den FAQs auf [weber.com](http://weber.com).

**ES** Apriete los herrajes hasta que estén bien sujetos.

**⚠ NO APRIETE EXCESIVAMENTE LOS HERRAJES.** Consulte nuestras FAQs en [weber.com](http://weber.com) para ver vídeos y recibir orientación acerca del montaje de la bisagra.

**FI** Kiristä kiinnikkeet kunnolla.

**⚠ ÄLÄ KIRISTÄ KIINNIKKEITÄ LIIKAA.**

Saranan asennusvideon ja -ohjeet löydät UKK-osioista osoitteessa [weber.com](http://weber.com).

**FR** Serrer fermement les vis.

**⚠ NE PAS TROP SERRER LES VIS.**

Pour avoir accès à des vidéos et conseils d'assemblage de la charnière, consulter nos FAQ sur [weber.com](http://weber.com).

**IT** Stringere la minuteria fino a quando non è ben serrata.

**⚠ NON STRINGERE ECCESSIVAMENTE**

**LA MINUTERIA.** Per video e la guida all'assemblaggio della cerniera, vedere le domande frequenti su [weber.com](http://weber.com).

**NL** Bevestig de hardware totdat deze goed vast zit.

**⚠ NOOIT HARDWARE TE VAST BEVESTIGEN.**

Voor video's en ondersteuning bij het monteren van de scharnier kunt de veelgestelde vragen bekijken op [weber.com](http://weber.com).

**NO** Stram utstyret til det er sikret.

**⚠ IKKE STRAM UTSTYRET FOR HARDT.** For videoer og veiledning for montering av hengselet, sjekk «Ofte stilte spørsmål» på [weber.com](http://weber.com).

**PL** Dokręć do oporu elementy mocujące.

**⚠ NIE DOKRĘCAJ ZBYT MOCNO ELEMENTÓW**

**MOCUJĄCYCH.** Filmy i wskazówki dotyczące montażu zawiasu można znaleźć w części poświęconej często zadawanym pytaniom na stronie [weber.com](http://weber.com).

**PT** Aperte as ferragens até estarem bem seguras.

**⚠ NÃO APERTAR AS FERRAGENS DEMASIADO.**

Para vídeos e orientação relativamente à montagem da dobradiça, consulte as nossas FAQs em [weber.com](http://weber.com).

**RU** Затяните оборудование, пока оно не будет плотно зафиксировано.

**⚠ НЕ ПЕРЕТЯГИВАЙТЕ ОБОРУДОВАНИЕ.**

Видео и руководство по монтажу петли представлены в разделе часто задаваемых вопросов на веб-сайте [weber.com](http://weber.com).

**SV** Dra åt muttrar och beslag tills de sitter fast.

**⚠ DRA INTE ÅT MUTTRAR OCH BESLAG FÖR HÅRT.**

Under FAQ på [weber.com](http://weber.com) hittar du videoklipp och vägledning om hur du monterar gångjärnet.

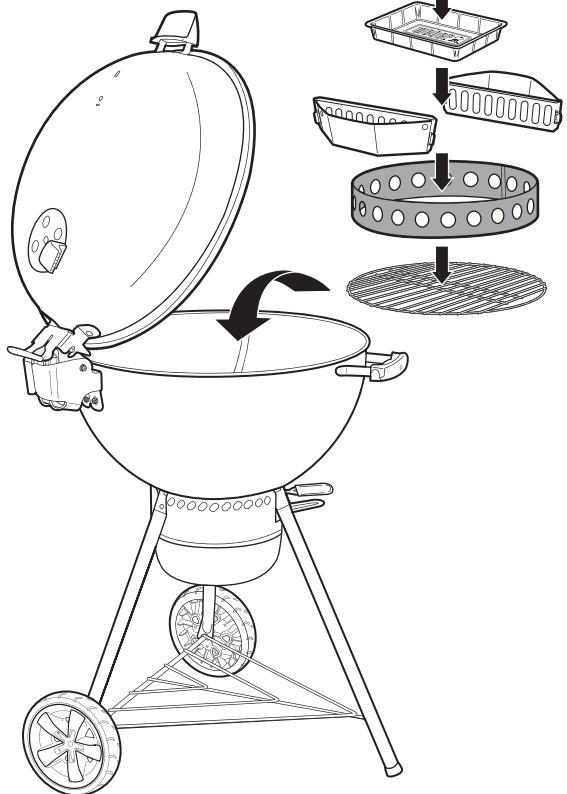

**EN** This part only applies to the MASTER-TOUCH Premium SE E-5775.

**DA** Denne del gælder kun for MASTER-TOUCH Premium SE E-5775.

**DE** Dieses Teil ist nur beim MASTER-TOUCH Premium SE E-5775 verfügbar.

**ES** Esta pieza sólo se incluye con el modelo MASTER-TOUCH Premium SE E-5775.

**FI** Tämä osuus koskee vain mallia MASTER-TOUCH Premium SE E-5775.

**FR** Cette partie est valable uniquement pour le MASTER-TOUCH Premium SE E-5775.

**IT** Questa parte è applicabile solo a MASTER-TOUCH Premium SE E-5775.

**NL** Dit deel is alleen van toepassing op de MASTER-TOUCH Premium SE E-5775.

**NO** Denne delen gjelder bare for MASTER-TOUCH Premium SE E-5775.

**PL** Ta część instrukcji dotyczy wyłącznie MASTER-TOUCH Premium SE E-5775.

**PT** Peça aplica-se ao MASTER-TOUCH Premium SE E-5775.

**RU** Эта часть применима только к MASTER-TOUCH Premium SE E-5775.

**SV** Den här delen gäller endast för MASTER-TOUCH Premium SE E-5775.

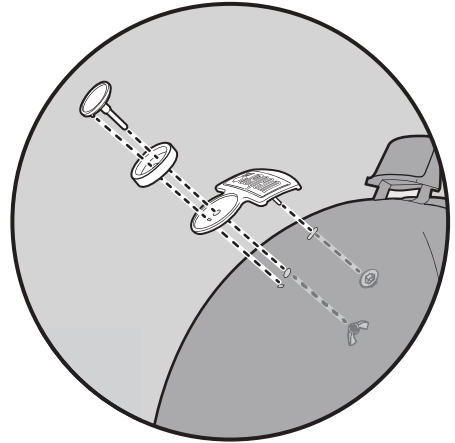
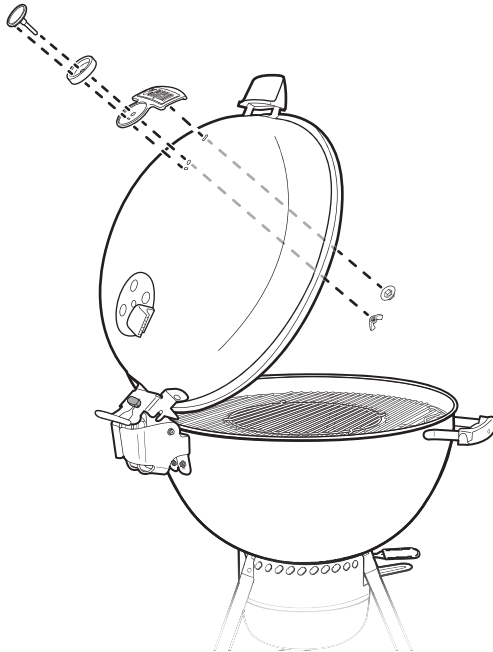
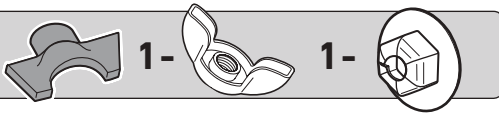
**24****25**

- EN** FOR USE WITH iGRILL MINI and iGRILL 2.
- DA** TIL brug med iGRILL MINI og iGRILL 2.
- DE** FÜR DEN GEBRAUCH MIT DEM iGRILL MINI UND iGRILL 2.
- ES** COMPATIBLE CON iGRILL MINI E iGRILL 2.
- FI** iGRILL MINI- ja iGRILL 2 -yhteensoviva.
- FR** COMPATIBLE AVEC iGRILL MINI ET iGRILL 2.
- IT** PER L'USO CON iGRILL MINI e iGRILL 2.
- NL** VOOR GEBRUIK MET DE iGRILL MINI en iGRILL 2.
- NO** FOR BRUK MED iGRILL MINI og iGRILL 2.
- PL** DO UŻYTKU Z iGRILL MINI ORAZ iGRILL 2.
- PT** PARA USAR COM O iGRILL MINI e iGRILL 2.
- RU** ДЛЯ ИСПОЛЬЗОВАНИЯ С iGRILL MINI и iGRILL 2.
- SV** FÖR ANVÄNDNING MED iGRILL MINI och iGRILL 2.

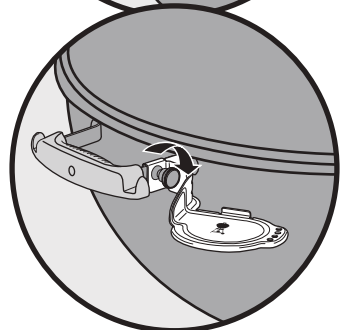
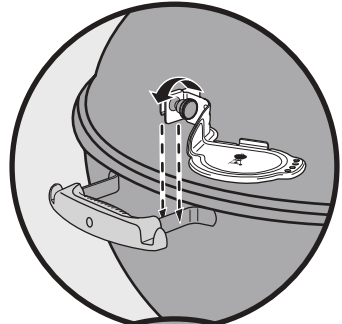

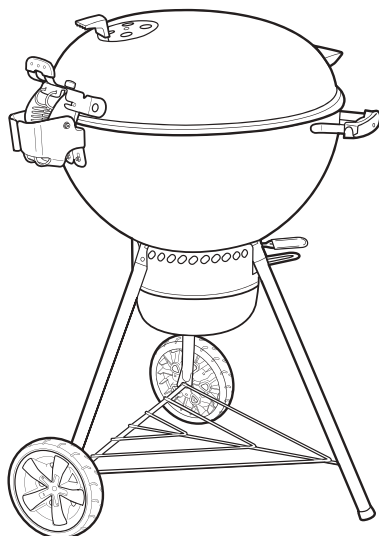

- EN** Make sure that all parts are assembled and hardware is fully tightened before operating the barbecue.
- DA** Sørg for, at alle dele er monteret og tilspændt korrekt, inden grillen tages i brug.
- DE** Vergewissere dich, dass alle Teile ordnungsgemäß montiert und alle Befestigungselemente fest angezogen sind, bevor du den Grill öffnest.
- ES** Compruebe el correcto montaje de todas las piezas y apriete bien los herrajes antes de usar la barbacoa.
- FI** Varmista ennen grillin käyttöä, että kaikki osat on koottu oikein ja kiinnikkeet on kiristetty.
- FR** Assurez-vous que toutes les pièces ont été utilisées et que les vis sont bien serrées avant d'allumer le barbecue.
- IT** Prima di utilizzare il barbecue, assicurarsi che tutte le parti siano assemblate e che la minuteria sia completamente serrata.
- NL** Zorg ervoor dat alle onderdelen zijn gemonteerd en volledig zijn vastgedraaid voordat u de barbecue gebruikt.
- NO** Sørg for at alle deler er montert og at de er godt festet før du bruker grillen.
- PL** Przed przystąpieniem do korzystania z grilla upewnij się, że wszystkie części zostały zmontowane i że wszystkie śruby są mocno dokręcone.
- PT** Antes de usar o grelhador, certifique-se de que todas as peças estão montadas e as ferragens bem apertadas.
- RU** Перед началом эксплуатации гриля необходимо убедиться в том, что все компоненты собраны, а оборудование надежно зафиксировано.
- SV** Kontrollera att alla delar är monterade och att muttrarna är helt åtdragna innan grillen används.



WEBER-STEPHEN PRODUCTS LLC  
www.weber.com